



SANITARY WARE • PORCELAINE SANITAIRE

**T-0059SF** (A-005) (ADA Toilet)

**One-piece elongated comfort height toilet**

Toilette monopièce allongée à hauteur confort



**PERFORMANCE**

KIOO's low consumption toilets are designed with a powerful siphon jet flush system. They also offer a large water surface and glazed trapway. They all meet or exceed the following specifications.

Les toilettes à faible consommation d'eau de KIOO sont conçues avec un puissant système d'évacuation à siphon. Elles offrent aussi un grande surface d'eau et un drain verni, en plus de rencontrer ou d'excéder les spécifications suivantes.

**SPECIFICATIONS | SPÉCIFICATIONS**

WATER USE UTILISATION D'EAU	4/6Lpf (1.1/1.6Gpf) 4/6LPPF (1.1/1.6GPPF)
FLUSH SYSTEM SYSTÈME D'ÉVACUATION	3" flush valve (clapper)   1000 g Valve d'évacuation de 3" (clapet)   1000 g
FLUSH BUTTON BOUTON DE LA CHASSE	Polished chrome knob push on side Bouton au fini chrome poli placé sur le côté
TRAPWAY DIAMETER DIAMÈTRE DU SIPHON	2" siphon (ø50 mm)
ROUGH-IN DRAIN D'ÉVACUATION	12" (305 mm)
MATERIAL MATÉRIEL	Vitreous china   Water absorption under 0.5% Porcelaine vitrifiée   Absorption d'eau sous 0.5%
SEAT SIÈGE	Soft-close feature included   Quick-Release feature (removable) Fermeture progressive incluse   Amovible
TRAPWAY TYPE TYPE DE SIPHON	Concealed Dissimulé
BOWL TYPE TYPE DE CUVE	Elongated Allongée



**Caution: Use proper support to mount product.**

**Attention: Utilisez un support approprié pour installer le produit.**

Fixture dimensions and hydraulic performance meet or exceed CSA requirements. Les dimensions du produit et sa performance hydraulique rencontrent ou excèdent les exigences du CSA.

These dimensions and specifications are subject to change without notice. Ces dimensions et spécifications sont sujettes à changement sans préavis.

**ENZO**

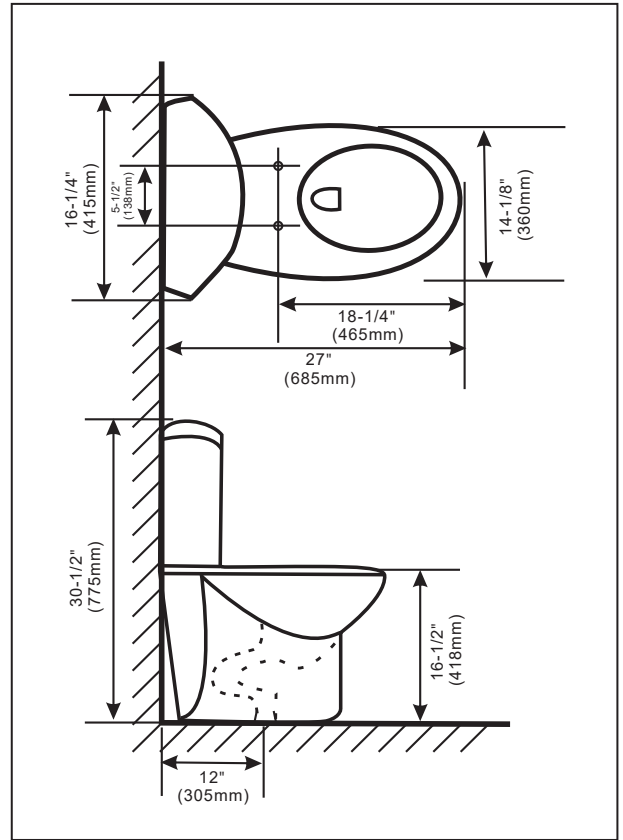

**INCLUDED | INCLUS**



Seat | Siège  
RP-TS392SFQ



Parts | Pièces  
Input valve | Valve d'entrée  
RP-FIV009  
Output valve | Valve de sortie  
RP-FSV026  
Flush lever | Clanche  
RP-CL021



CUPC FILE NO.: 9531

WATER SENSE (HET) FILE NO: 9530

CERTIFIED MODEL: GF-A005

For more information, visit our website at [bathdepot.ca/kioo-brand](http://bathdepot.ca/kioo-brand)

Pour plus d'informations, visitez notre site web à [baindepot.com/marque-kioo](http://baindepot.com/marque-kioo)

# INSTALLATION INSTRUCTIONS | INSTRUCTIONS D'INSTALLATION

## Installation Drawing

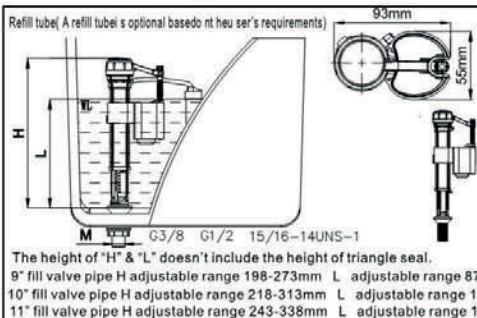

### Instructions

- 1) Please read carefully the following installation instructions in order to avoid component damage or injury to the installer.
- 2) The instructions have been composed based in the latest product specifications. We reserve the right to make modifications to the packaging and specifications without providing prior notification.
- 3) When installing the fill valve, the critical level on the fill valve (identified on the valve marked "CL") should be at least 1" (25.4mm) above the top of the overflow pipe of the flush valve. This is a plumbing code.
- 4) We shall not be responsible for failures that are contributed to the use of parts other than those specified.
- 5) Water Temperature: 2°C to 45°C
- 6) Water Pressure Range: 0.02Mpa (0.2 Bar) to 0.8Mpa (8 Bar)



### Warning

DO NOT USE OR DROP ANY CHLORINE OR ANY CHEMICAL RELATED COMPONENTS. USE OF SUCH PRODUCTS WILL RESULT IN DAMAGE TO TANK COMPONENTS AND MAY CAUSE FLOODING AND PROPERTY DAMAGE AND VOID WARRANTY.

DO NOT OVERTIGHTEN NUTS, OR TANK/BOWL MAY CRACK.

**I Work Preparation:** Remove the inoperative tank fittings and carefully clean the water cistern/tank. Make sure all debris has been removed prior to installing new tank fittings.

## II Water Level Adjustment

### (1) Major Water Adjustments

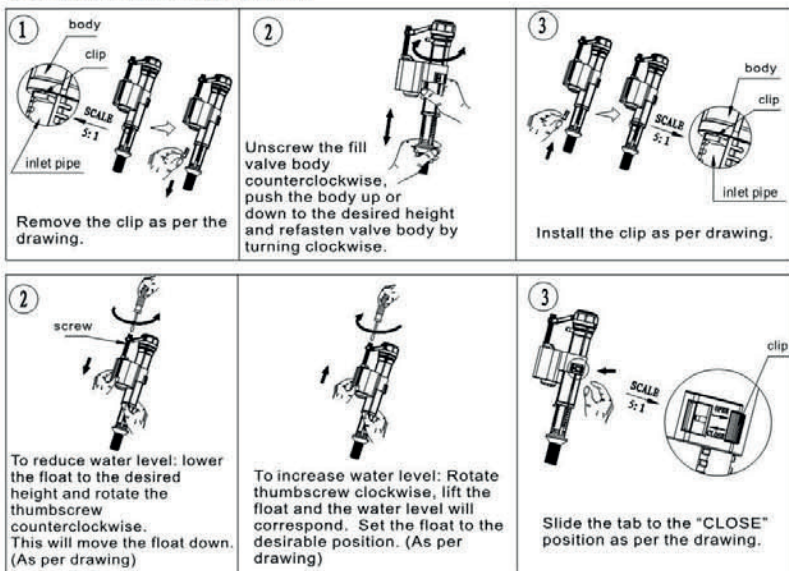

### (2) Minor Water Adjustments

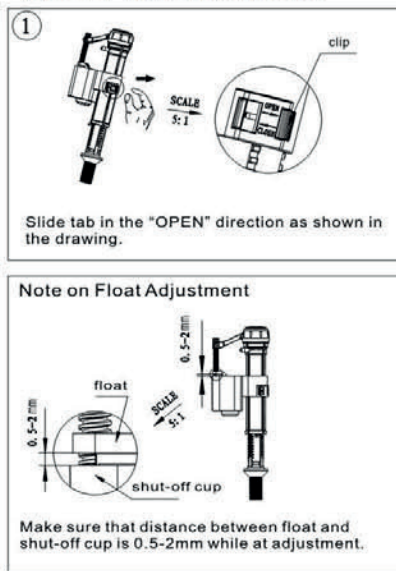

## III Fill Valve Installation

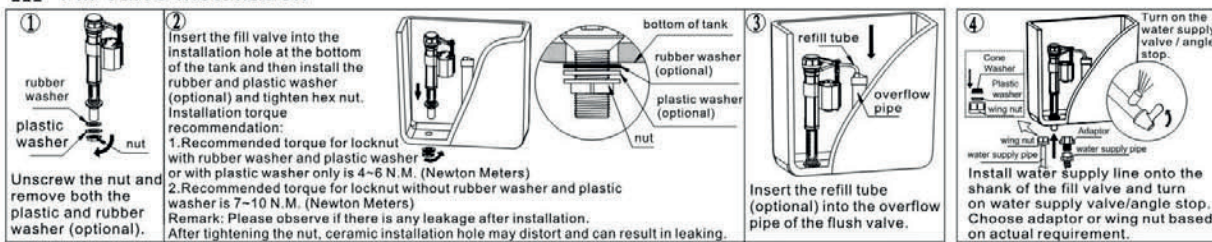

## IV. Cleaning Filter (Filter which is located inside the inlet valve shank is required for cleaning periodically)

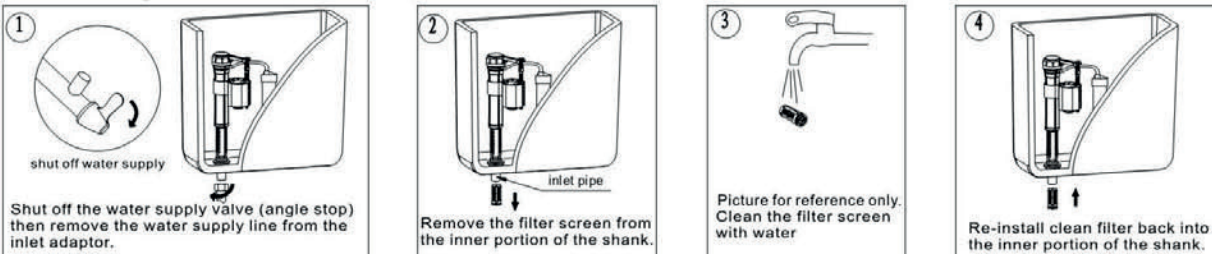

## V. Troubleshooting

Issue	Cause	Resolution
Water line is too high or too low	Inlet valve is not adjusted to a suitable position	Adjust the water level to the appropriate water level
Inlet valve does not shut off.	1) The cistern/tank wall has blocked the movement of the inlet valve float 2) The refill tube wasn't installed properly 3) Leakage of flush valve. 4) The water level is above overflow pipe of flush valve.	1) Adjust the fill valve to the appropriate position and make sure float can move freely. 2) See figure attached to re-install refill tube correctly. 3) Make sure none leakage of flush valve. 4) Re-adjust water level and installation height to appropriate position.
Inlet valve does not turn on.	1) Water supply valve/angle stop is off. 2) The cistern/tank wall has blocked the movement of the inlet valve float. 3) Filter screen is dirty	1) Turn on the water supply valve/angle stop. 2) Adjust the fill valve to the appropriate position and make sure float can move freely. 3) Clean filter screen

### Installation of refill tube :

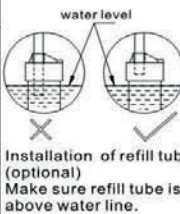

Thank you for choosing our product. You may contact our local dealer directly for prompt service if you have any questions.



# INSTALLATION INSTRUCTIONS | INSTRUCTIONS D'INSTALLATION

Work Preparation: Remove the inoperative tank fittings and carefully clean the water cistern/tank. Make sure all debris has been removed prior to installing new tank fittings.

Note : 1. This device is not intended to be used as retrofit device for 1.28 gpf water closet.  
2. Performance may vary since product was not tested on all models of water closets

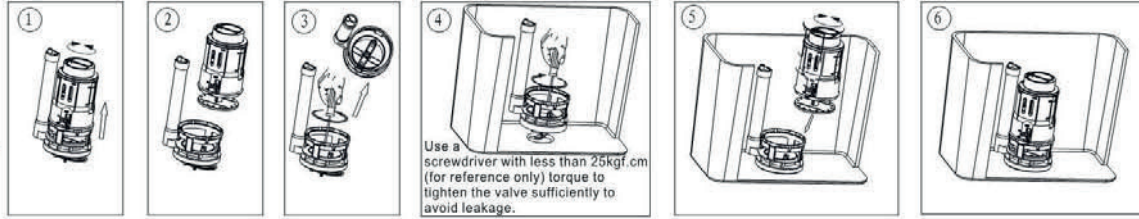
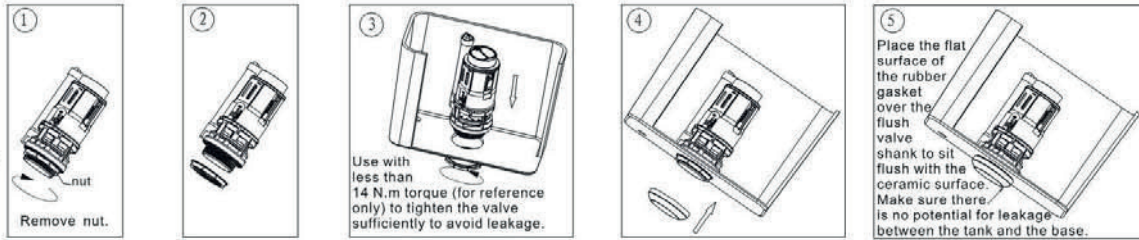
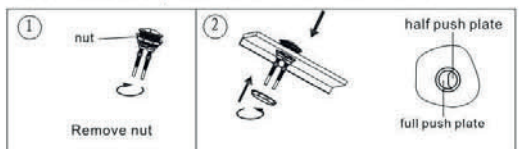
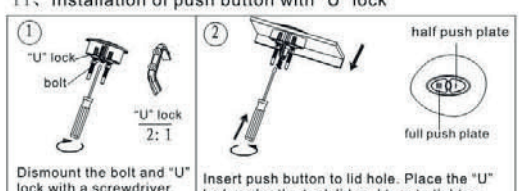
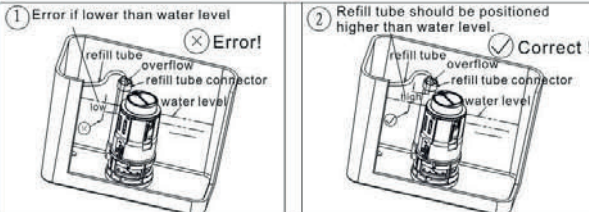
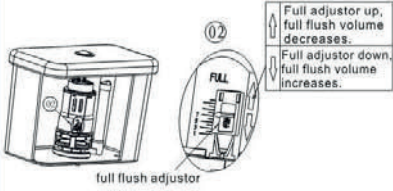
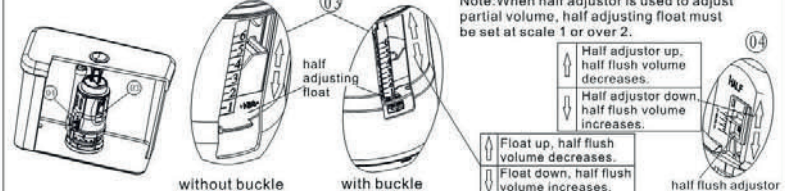
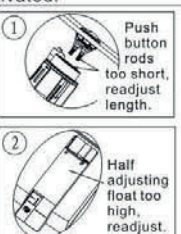
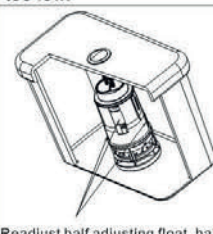
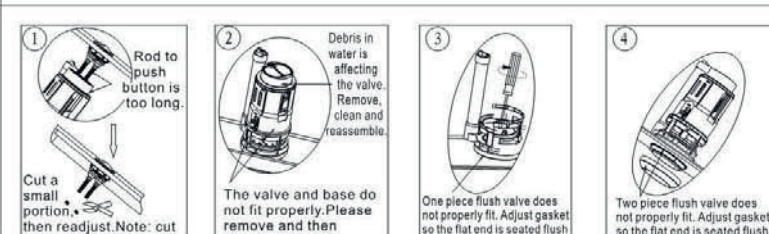
<p>Flush valve installation</p>	<p>One piece flush valve installation</p>  <p>Use a screwdriver with less than 25kgf.cm (for reference only) torque to tighten the valve sufficiently to avoid leakage.</p>
<p>Two piece flush valve installation</p>	<p>Two piece flush valve installation</p>  <p>Remove nut.</p> <p>Use with less than 14 N.m torque (for reference only) to tighten the valve sufficiently to avoid leakage.</p> <p>Place the flat surface of the rubber gasket over the flush valve shank to sit flush with the ceramic surface. Make sure there is no potential for leakage between the tank and the base.</p>
<p>Installation of push button</p>	<p>I. Installation of push button with screw and nut</p>  <p>Remove nut</p> <p>half push plate</p> <p>full push plate</p> <p>II. Installation of push button with "U" lock</p>  <p>"U" lock bolt</p> <p>"U" lock 2:1</p> <p>Dismount the bolt and "U" lock with a screwdriver</p> <p>Insert push button to lid hole. Place the "U" lock under the tank lid and turn to tighten.</p> <p>half push plate</p> <p>full push plate</p> <p>Adjust valve clockwise or counterclockwise to insure rod aligns and falls on push plate.</p> <p>If the rod is too short or long, move the rod by turning it up or down to obtain a suitable position then tighten it with the adjusting nut.</p> <p>locknut</p> <p>rod</p> <p>full push plate</p> <p>half push plate</p>
<p>Refill tube installation and adjustment</p>	<p>Note: A refill tube is optional based on the user's requirements</p>  <p>① Error if lower than water level</p> <p>② Refill tube should be positioned higher than water level.</p> <p>Instructions</p> <ol style="list-style-type: none"> <li>Please read carefully the following installation instructions in order to avoid component damage or injury to the installer.</li> <li>The instructions have been composed based in the latest product specifications. We reserve the right to make modifications to the packaging and specifications without providing prior notification.</li> <li>When installing the fill valve, the critical level on the fill valve (identified on the valve marked "CL") should be at least 1" (25.4mm) above the top of the overflow pipe of the flush valve. This is a plumbing code.</li> <li>We shall not be responsible for failures that are contributed to the use of parts other than those specified.</li> <li>Water Temperature: 2°C to 45°C</li> <li>Water Pressure Range: 0.02Mpa (0.2 Bar) to 0.8Mpa (8 Bar)</li> </ol> <p>DO NOT USE OR DROP ANY CHLORINE OR ANY CHEMICAL RELATED COMPONENTS. USE OF SUCH PRODUCTS WILL RESULT IN DAMAGE TO TANK COMPONENTS AND MAY CAUSE FLOODING AND PROPERTY DAMAGE AND VOID WARRANTY.</p> <p>DO NOT OVERTIGHTEN NUTS, OR TANK/BOWL MAY CRACK.</p> <p>warning</p>
<p>Adjustment of flush volume</p>	<p>I. Adjustment of full flush volume</p>  <p>full flush adjuster</p> <p>②</p> <p>Full adjuster up, full flush volume decreases.</p> <p>Full adjuster down, full flush volume increases.</p> <p>II. Adjustment of half flush volume</p>  <p>half adjusting float</p> <p>without buckle</p> <p>with buckle</p> <p>Note: When half adjuster is used to adjust partial volume, half adjusting float must be set at scale 1 or over 2.</p> <p>④</p> <p>Half adjuster up, half flush volume decreases.</p> <p>Half adjuster down, half flush volume increases.</p> <p>Float up, half flush volume decreases.</p> <p>Float down, half flush volume increases.</p> <p>half flush adjuster</p>
<p>Troubleshooting</p>	<p>Little or no flush volume when the push button is activated.</p>  <p>① Push button rods too short, readjust length.</p> <p>② Half adjusting float too high, readjust.</p> <p>Full flush or half flush water level is too high or too low.</p>  <p>Readjust half adjusting float, half adjuster or full adjuster.</p> <p>Leaking</p>  <p>① Rod to push button is too long.</p> <p>Cut a small portion, then readjust. Note: cut the upper end of the rod.</p> <p>② Debris in water is affecting the valve. Remove, clean and reassemble.</p> <p>The valve and base do not fit properly. Please remove and then reassemble.</p> <p>③ One piece flush valve does not properly fit. Adjust gasket so the flat end is seated flush with the ceramic.</p> <p>④ Two piece flush valve does not properly fit. Adjust gasket so the flat end is seated flush with the ceramic.</p>

Thank you for choosing our product. You may contact our local dealer directly for prompt service if you have any questions.

## Installation Guide

### 1 Parts

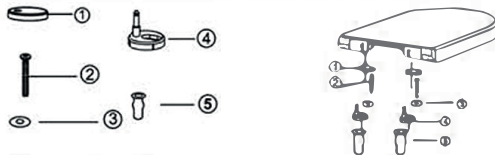

NO.	Description	Qty
1.	Stainless Steel Hinge cap	2
2.	Bolt	2
3.	Washer	2
4.	Hinge Base	2
5.	Rubber Cork	2

### 2 Installation Guide

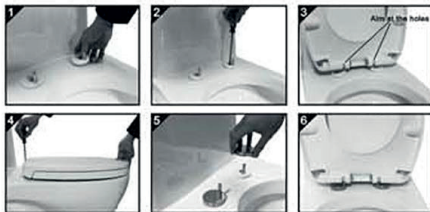

1. Insert the screw set on the hinge base through the holes on the pan.
2. Tighten the seat screws, but not fully allowing you movement to adjust the seat cover properly.
3. Aim at the holes and adjust the Hinge base to make the seat cover and pan match. Take out the seat cover once the installation position is confirmed.
4. Fix the hinge base on the pan firmly.
5. Put the cap into the hinge base.
6. Fix the seat cover into the hinge base.

## SOFT-CLOSE SEAT COVER



### 3 Innovation Functions

ENTIRELY NEW SUPPORT MAKES YOUR ROOM TIDY AND CLEAN



Free rotation

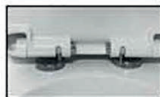

Easy Installation



Fast lift & clean



Slow Close & Longer Life



Integrated Design and Strong Enough to last



Neatness and Clean Smooth Surface

Please abide by the following illustrations to ensure safety

Please read this notice carefully before operation. This manual lists many different kinds of warning marks to avoid injury to your body or loss or damage of property. The marks and explanations are as follows, please keep in plain sight.

**Warning!** It may cause injury to your body or property damage if you ignore this mark.  
● means "forbidden".



Warning!



Do not stand on the toilet cover, and do not place heavy objects on it. (this may cause cracking)



Do not clean the toilet seat with household cleaners, volatile, thinner and eradicator, or use nylon brush and avoid chlorine-containing, corrosive and a abrasive cleaners. Maintain the shiny surface by using soft fabric and clean water. (Or else it may cause abrasion or crack.)



Do not let children play with the toilet cover, to avoid trapped or hurt fingers and other accidents



### 4 Relative Notice

Open and close the toilet seat cover tenderly (or this may cause this to crack)

Avoid sunlight and other artificial light sources (or this may affect the colour)



- Both the toilet seat and cover have the function of slow closing
- The closing speed varies dependent on room temperature and usage frequency
- Please open the toilet seat and cover completely, otherwise the functionality of slow closing will fall and may cause injury to fingers or other body parts

### 5 Maintenance

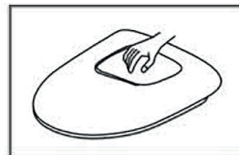

#### 1. Periodical maintenance

- Wipe gently with wet fabric.
- Wipe off dirt

Wash this with neutral cleaners (such as soap powder) gently drying with clean fabric

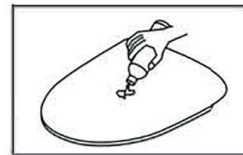

#### 2. Cleaners

- Do not wipe or wash the toilet seat and cover with abrasive powder or cleaning products
- Do not use disinfectant, germ cleaner or other aerosol cleaners
- Please note that some chemical and caustics used in the bathroom may damage the toilet seat and cover



# INSTALLATION INSTRUCTIONS | INSTRUCTIONS D'INSTALLATION

## GUIDE D'INSTALLATION

### INSTALLATION GUIDE

1- La dimensions des équerres d'installation de type sept, vis à plancher (70 mm  $\varnothing$  6mm), manchons en plastique (60mm  $\varnothing$  8mm) et la vis de montage de toilette (90mm  $\varnothing$  4mm)

1- Size of seven-type mounting brackets, floor screws (70mm,  $\varnothing$ 6mm), plastic sleeves(60mm,  $\varnothing$  8mm) and toilet bowl mounting screws (90mm,  $\varnothing$  4mm).

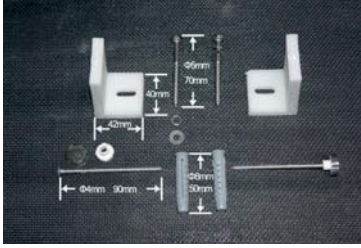

2- Voici la liste des outils qui seront nécessaires à l'installation: perceuse, marteau, tournevis, colle pour le verre, règle triangulaire ...

2- The tools required for installation are: Drill, hammer, screwdriver, glue for glass, Triangular rule ...



3- Dessinez un guide en forme de croix qui se trouve à 305 mm ( 12" ) de la parois du mur. Il faut que le guide soit centré par rapport à la parois du mur.

3- Draw a cross guideline at the point which is 305mm (12") away from the roughing in center to the wall.

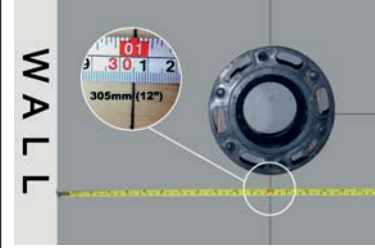

4- Selon la feuille d'instruction, découpez la sortie du drain qui se trouve sur la feuille d'instruction. Puis placer le papier alignez sur la bride du sol.

4- According to the instruction, cut the drain outlet from the paper, and then put the paper on the floor flange.



5- Selon l'emplacement indiqué sur la feuille d'instruction, percez deux trous (Diamètre 8mm) pour les vis du sol.

5- According to the instructed location in the instruction, drill two holes (diameter of which is 8 mm) for the floor screws.

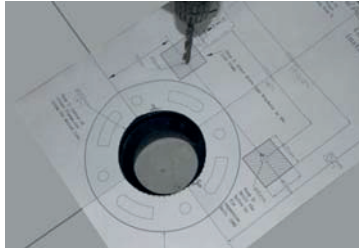

6- Insérez les manchons en plastique puis fixez les des équerres d'installation de type sept puis installez les vis à plancher.

6- Insert the plastic sleeves, attach the seven-type mounting brackets and install the floor screws.

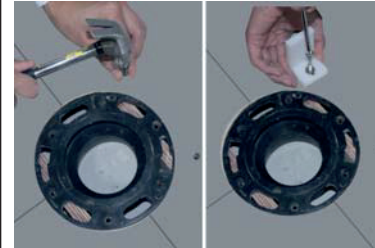

7- Ajustez les équerres d'installation et serrez les vis. Il faut s'assurer qu'il y a 206 mm ( 8 1/8" ) entre le bord des équerres d'installation.

7- Adjust the mounting brackets and then tighten the screws. Make sure that it is 206mm (8 - 1 / 8") between the out edge of the seven-type brackets.

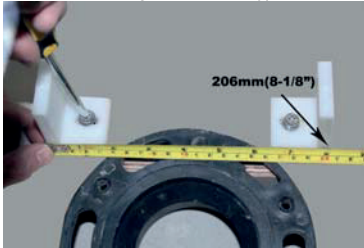

8- Installer la cire à l' orifice d'évacuation de cuvette de toilettes .

8- Stick the wax to the drain hole of toilet bowl.

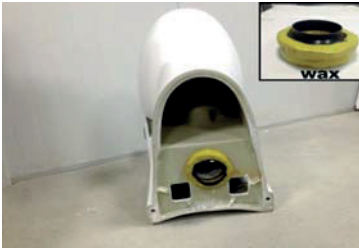

9- Mettre le bol de toilette par dessus par bride de plancher et ajuster la toilette afin qu'elle soit proche de la parois du mur.

9- Put the toilet bowl above the floor flange and adjust the toilet bowl to be closed to wall.



10- Serrez les vis de la toilette puis mettre les chapeaux.

10. Tighten the toilet bowl mounting screws and then put on the caps.



11- L'installation est complétée.

11. Installation complete.



## GARANTIE LIMITÉE

En choisissant un produit KIOO, leader dans l'industrie de la plomberie, vous vous assurez de faire le bon choix. En plus des matériaux de qualité utilisés dans la conception de ses produits, ses procédés de fabrication évolués profitent aussi à leur qualité et leur longévité. C'est pour en faire foi que KIOO a décidé d'offrir une garantie avantageuse à sa clientèle.

Nous vous certifions que nos produits sauront satisfaire vos besoins grâce à leur style, mais aussi par leur qualité de fabrication. Afin de vous assurer fiabilité et sécurité, chaque produit a été minutieusement inspecté, testé puis approuvé lors d'un contrôle de qualité.

## À qui la garantie s'applique-t-elle?

KIOO offre une **garantie limitée de 5 ans** à partir de la date d'achat, exclusive au premier acheteur et tant qu'il réside dans la propriété. Cette garantie s'applique sur toutes les toilettes KIOO. La garantie est destinée à un usage résidentiel et/ou domestique.

## Consignes d'entretien

Le siège de toilette doit seulement être nettoyé à l'eau, à l'aide d'un détergent doux. Les détergents abrasifs ou corrosifs, la laine d'acier, les brosses de nylon, l'acétone, les produits de nettoyage à sec ou les composés d'ammoniac ne doivent jamais être utilisés pour nettoyer les surfaces du produit.

## Que couvre la garantie?

	1 an*	5 ans*
<b>Toilettes</b>	Système d'évacuation	Porcelaine
<b>Lavabos / Vasques</b>	Trop-plein et drain	Porcelaine
<b>Pièces</b>	Levier, valve, siège, capuchon, chaîne, joint d'étanchéité, vis, flexible, citerne encastrée et plaque de contrôle	—

\*À partir de la date d'achat

S'il y a des défauts de fabrication couverts par la garantie, le produit devra être inspecté avant de donner suite à toute réclamation. Sans cette vérification, aucun frais et/ou responsabilité ne seront assumés par la marque.

## Quelles sont les exclusions?

Cette garantie est applicable pour tous les produits KIOO achetés en date du 1<sup>er</sup> janvier 2018 ou après.

La garantie ne s'applique pas si le produit est endommagé suite à une utilisation non conforme, à un usage abusif ou non résidentiel, à de la négligence, à un manque d'entretien, ou en raison de l'utilisation de produits corrosifs ou abrasifs, et ce peu importe qui est responsable de ces dommages. La garantie ne couvre pas les frais d'expédition et de main-d'œuvre. KIOO ne couvre pas l'usure normale des composantes.

Dans le cas où l'alimentation en eau se fait à partir d'un puits, il se pourrait que le rendement du produit soit affecté, ce qui n'est pas couvert par la garantie.

La garantie ne couvre pas les dommages causés par les actes de Dieu ou les bris résultant d'un choc ou d'une mauvaise manutention, qu'elle fût de la part de l'acheteur ou de l'installateur. Elle exclut aussi les dommages qui résultent d'une mauvaise installation.

KIOO ne couvre pas les dommages aux biens causés par une fuite d'eau, que ceux-ci soient directement ou indirectement liés à un défaut du produit, sauf là où la législation applicable ne permet aucune exclusion ou limitation suite à des dommages indirects ou consécutifs.

Il est juste de préciser que s'il y a présence d'un défaut de fabrication sur le produit, il se manifestera dès l'installation ou peu de temps après. Par contre, si une fuite est causée par une mauvaise installation, elle ne pourra survenir que beaucoup plus tard. Il est donc fortement recommandé de faire appel à un professionnel.

**Toute demande de réclamation de garantie doit être accompagnée d'une copie de la facture.**

**Si une pièce ou composante du produit est défectueuse ou si le fini est endommagé dans le cadre d'un usage domestique et résidentiel normal, KIOO s'engage à remplacer, au premier acheteur uniquement, la ou les composantes défectueuses. KIOO pourrait aussi, et ce à son entière discrétion, s'engager à fournir un remplacement complet. Aucune indemnité ne pourra être réclamée suite à une perte de jouissance de la vie, à une perte de revenu ou aux pertes causées par l'eau.**

### LIMITED WARRANTY

By choosing a KIOO product, a leader in the plumbing industry, you are sure to make the right choice. On top of the quality materials that are used to make their products, KIOO's advanced manufacturing processes also benefit its products' quality and longevity. To attest to this, they decided to offer their customers a beneficial warranty.

We certify that our products will meet your needs with their style, but also with their manufacturing quality. To make sure that they are reliable and safe, each product was carefully inspected, tested and approved during the quality control process that is in place.

### To whom does this warranty apply?

KIOO offers a **5-year limited warranty** from the date of purchase, exclusive to the first buyer as long as he/she resides in the same property. This warranty applies to all KIOO toilets. The warranty is intended for residential and/or domestic use.

### Care instructions

The toilet seat must only be cleaned with water and a mild detergent. Abrasive or corrosive cleaners, steel wool, nylon brushes, acetone, dry cleaning products or ammonia compounds must never be used to clean the product.

### What is covered by the warranty?

	1 Year*	5 Years*
<b>Toilets</b>	Drainage system	Porcelain
<b>Bathroom Sinks / Vessel Sinks</b>	Overflow and drain	Porcelain
<b>Parts</b>	Lever, valve, seat, cap, chain, gasket, screws, flexible hose, concealed in-wall tank and control plate	—

\*From the date of purchase.

Should there be any manufacturing defects that are not covered by the warranty, the product will need to be inspected prior to following through with the claim. Without that verification, the brand will assume no charge and/or responsibility.

### What are the exclusions?

This warranty is applicable on all KIOO products purchased on or after January 1<sup>st</sup>, 2018.

The warranty doesn't apply if the product is damaged as a result of misuse, overuse or non-residential use, neglect, lack of maintenance, or the use of corrosive or abrasive products, regardless of the person who did those damages. The warranty does not cover shipping and labour costs. The warranty does not apply to the normal tear and wear of the goods.

In cases where the water supply is done through wells, the product's performance may be affected, which is not covered by the warranty.

The warranty doesn't cover the damages caused by the acts of God or breakage resulting from a shock or mishandling, regardless of the part played by the buyer or the installer. It also excludes the damages caused by an improper installation.

KIOO doesn't cover damages caused by a water leak, even if they result directly or indirectly from a product defect, except where the applicable legislation does not allow any exclusion or limitation following indirect or consequential damages.

It is fair to say that if the product has a manufacturing defect, it will show as soon as it is installed or shortly after. However, a leak caused by an improper installation could happen a long time after. Therefore, it is strongly advised to have it done by a professional.

**All warranty claims must include the invoice copy.**

**Should a part or product component be defective or the finish damaged following a normal domestic and residential use, KIOO commits to replacing the defective part(s) to the first buyer only. KIOO could also, in its sole discretion, commit to offer a full replacement. No indemnity shall be claimed for loss of enjoyment of life, loss of income or losses caused by water.**