

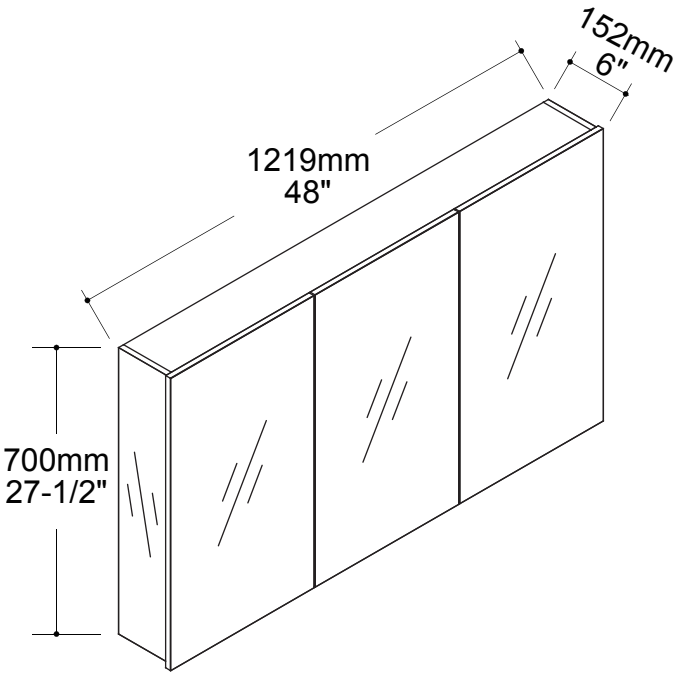







BATHROOM FURNITURES • MOBILIERS DE SALLE DE BAIN

Medicine Cabinet W/Mirror Pharmacie Avec Miroir

MG-M4827

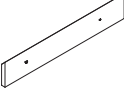

 5 x P	 48 x P₁	 5 x Q₂	 24 x V
	 2 x Z₃	 1 x S_m	

Étape 1 / Step 1

Étape 2 / Step 2

