

BATHROOM FURNITURES • MOBILIERS DE SALLE DE BAIN

Medicine Cabinet W/Mirror
Pharmacie Avec Miroir

19-M10071GWH

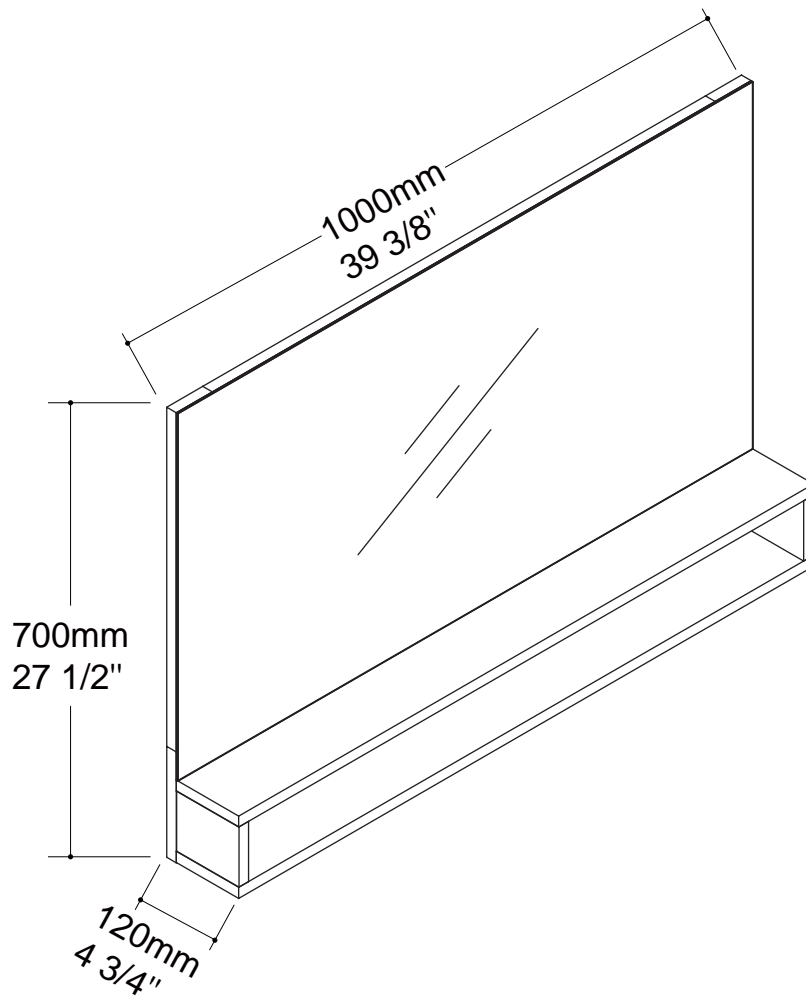

Tools You Will Need - Outils Requis



Power drill
Perceuse électrique





Screwdriver
Tournevis



Pencil
Crayon

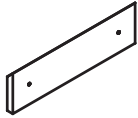

Silicone
Silicone

		
2 x P	2 x Q	1 x Sm

Instruction D'installation / Installation Instruction

Step 1 / Étape 1

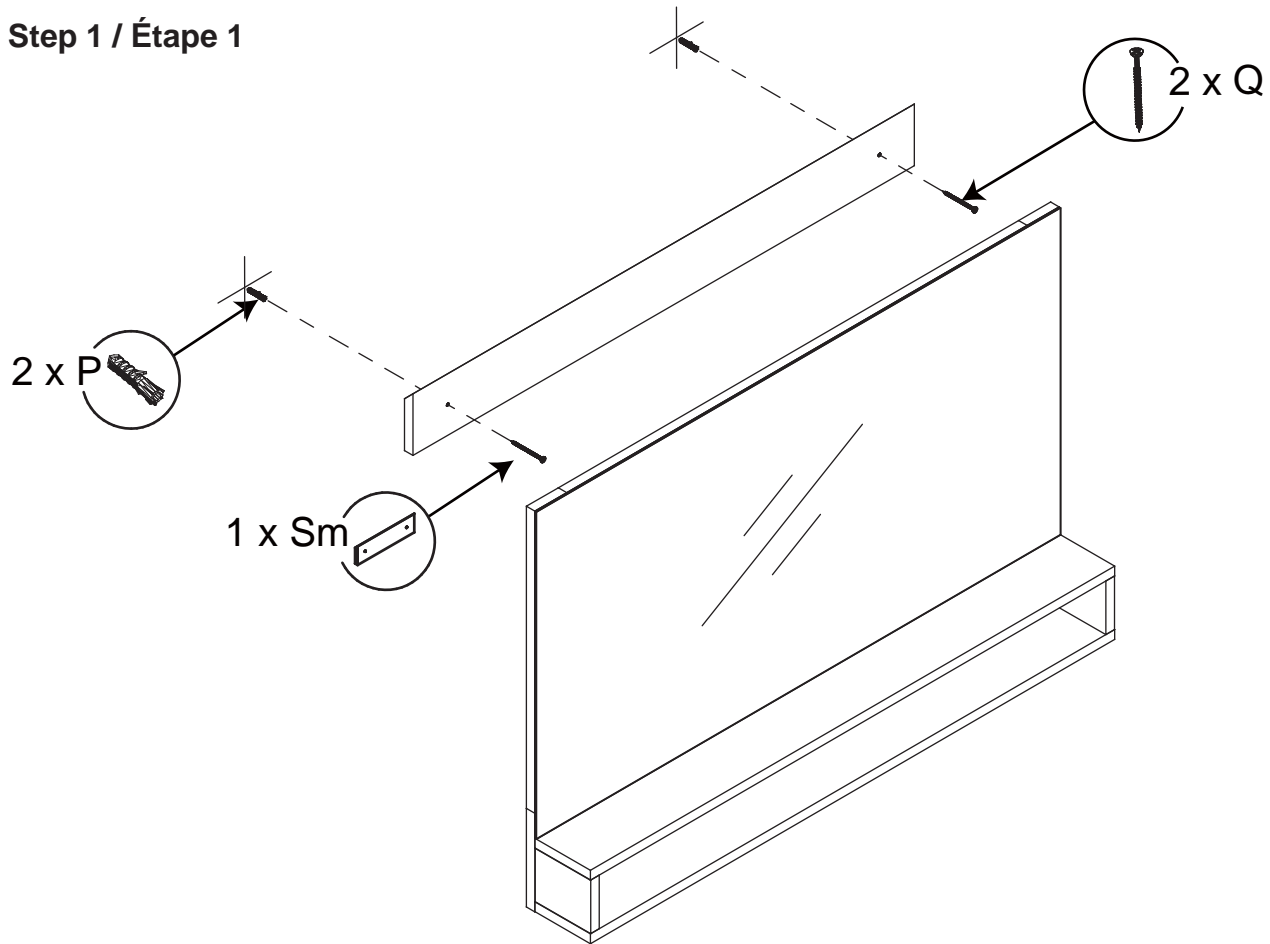

Step 2 / Étape 2

