



BATHROOM FURNITURE · MOBILIER DE SALLE DE BAIN

Vanity top · Dessus de Meuble-lavabo

VT-SQ73-4922

FOR SINGLE-HOLE INSTALLATION
***POUR INSTALLATION MONOTROU**

3 holes - 4" spread possible
*3 trous - 4" centre possible

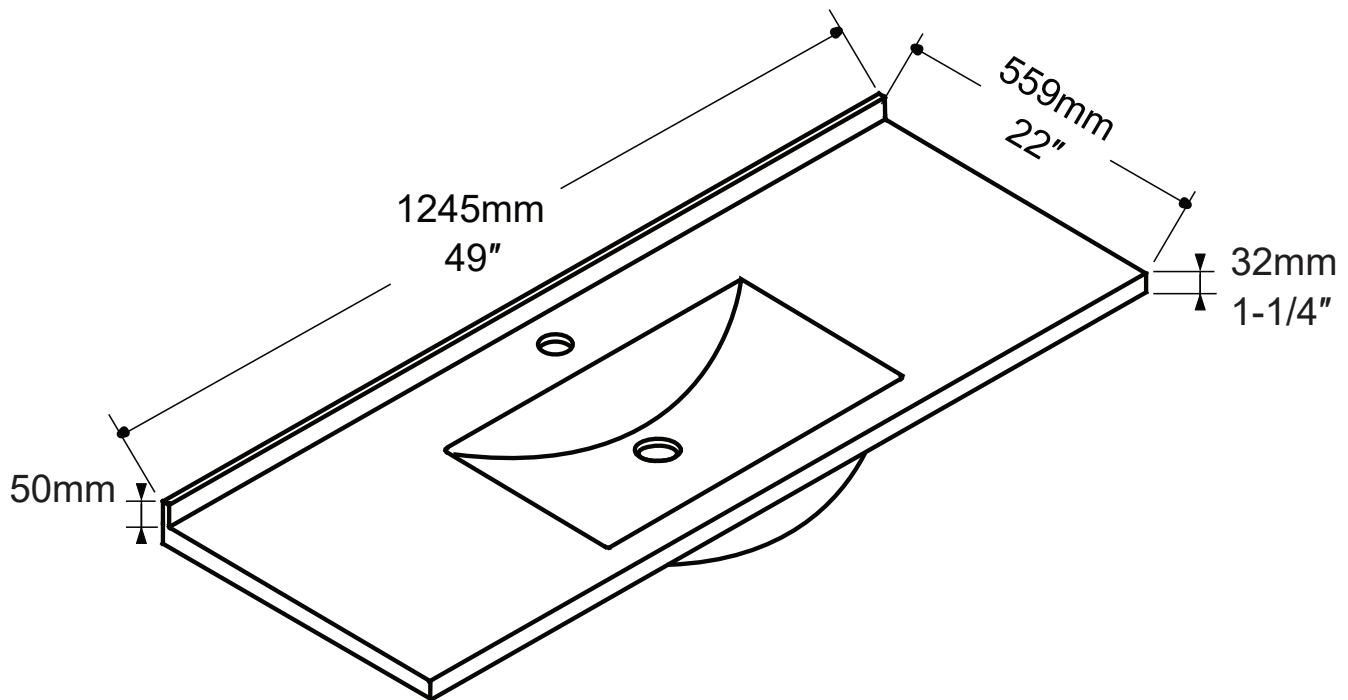

Tools You Will Need - Outils Requis



Power drill
Perceuse électrique



Drill bit 1/4"
Mèche de perceuse électrique 1/4"



Hole saw drill bit 1
Ø30mm to drill 4" faucet hole
Ø35mm to drill 8" faucet hole
Scie trépan
Ø30mm pour percé le trou robinet 4"
Ø35mm pour percé le trou robinet 8"



Hole saw drill bit 2
Ø30mm to drill 4" faucet hole
Ø35mm to drill 8" faucet hole
Scie trépan
Ø30mm pour percé le trou robinet 4"
Ø35mm pour percé le trou robinet 8"

Step 1 | Étape 1

Reverse the top
*Retourner le dessus

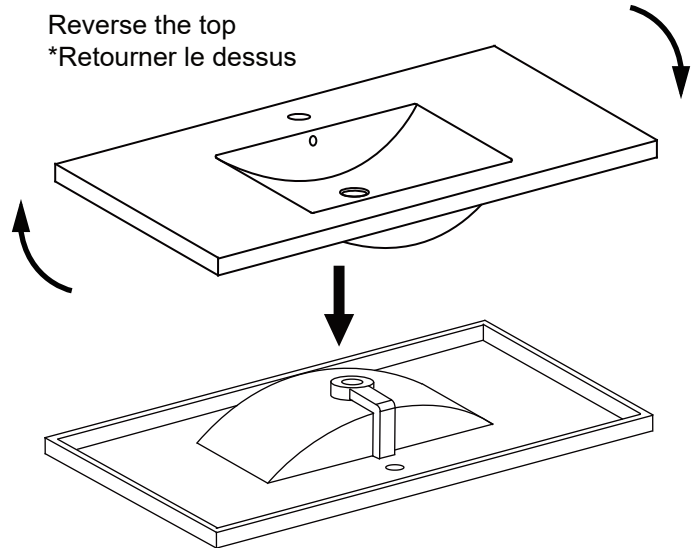

Step 2 | Étape 2

Measure from the center of the hole depending on the type of faucet to be installed. Mark the location.

*Mesurer à partir du centre du trou selon le type de robinet à installer. Marquer l'emplacement.

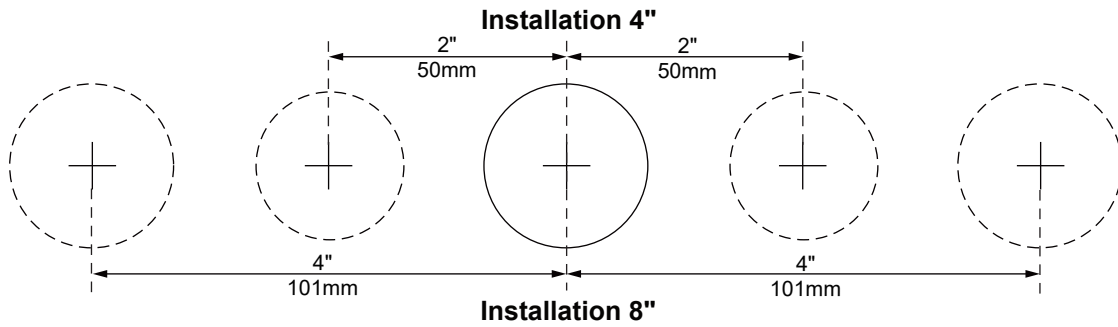

Reference only. Do not use as a template.
*Référence seulement. Ne pas utiliser comme gabarit.

Step 3 | Étape 3

Drill through 2 small holes at the marks from bottom side.

*Perçer 2 petits trous au niveau des marques à l'envers du dessus.

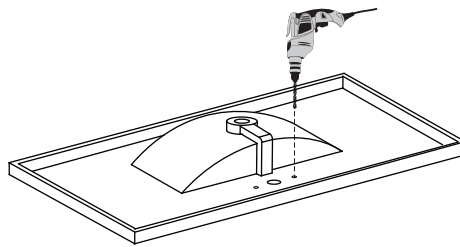

Step 4 | Étape 4

Drill through the 2 faucet holes from top side.

*Perçer les 2 trous de robinet sur le dessus.

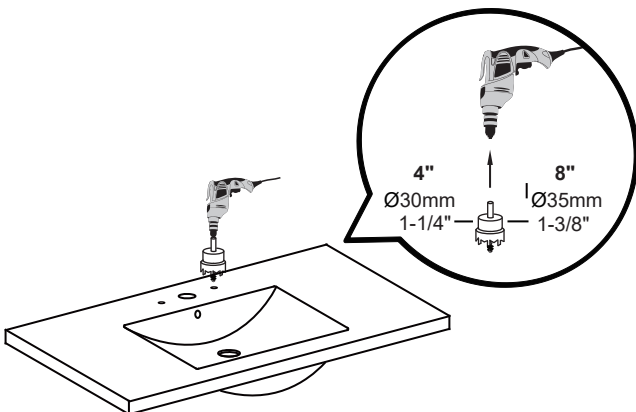

Step 5 | Étape 5

Smooth out the drilled faucet holes surface.

*Lisser les trous de robinet sur la surface.

